



Almacén de Fontanería

BAÑOS



SERIES DE PORCELANA ROCA

	MEDIDA	REF.	€
 <p>VICTORIA</p>	Lavabo 52	560210048	44,90
	Lavabo 56	560210051	51,00
	Lavabo 65	560210050	56,90
	Pedestal	560210052	39,70
	Semipedestal	560210049	36,80
	Taza S/V	560210055	67,80
	Taza S/H	560210056	67,80
	Depósito a/lateral	560210057	116,00
	Depósito a/inferior	560210053	116,00
	Asiento	560210059	49,20
 <p>THE GAP (compacto)</p>	Bidé	560210060	62,80
	TAPA Bidé	560210077	53,80
	Taza S/dual	560270255	161,00
	Depósito A/Inf	560270053	158,00
	Depósito A/Lateral	560270052	158,00
	Asiento	560270259	65,30
	Asiento amortiguado	560270258	122,00
	Bidé	560270260	120,00
	Tapa Bidé	560270061	57,30

REPUESTOS ROCA

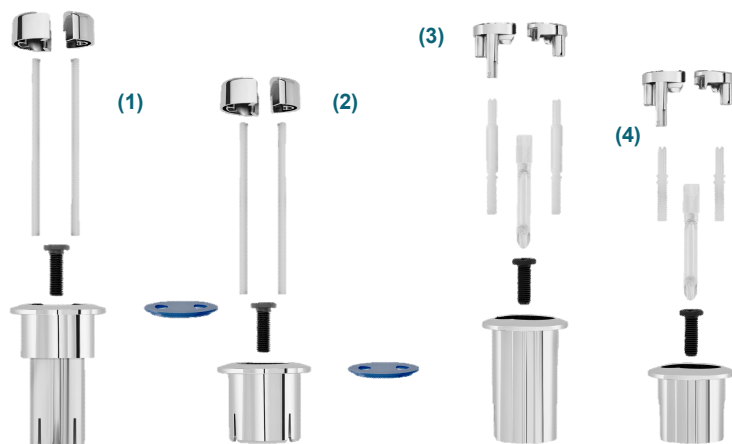

CONJUNTO DOBLE PULSADOR 3/6 LITROS (tapa 40 Ø)		
(1)	CONJUNTO PULSADOR LARGO VARILLA RECORTABLE PARA D1D	
	560208703	14,10
(2)	CONJUNTO PULSADOR CORTO VARILLA RECORTABLE PARA D1D	
	560208704	13,40
(3)	CONJUNTO PULSADOR LARGO VARILLA ROSCABLE PARA D2D	
	560208711	13,60
(4)	CONJUNTO PULSADOR CORTO VARILLA ROSCABLE PARA D2D	
	560208712	12,90

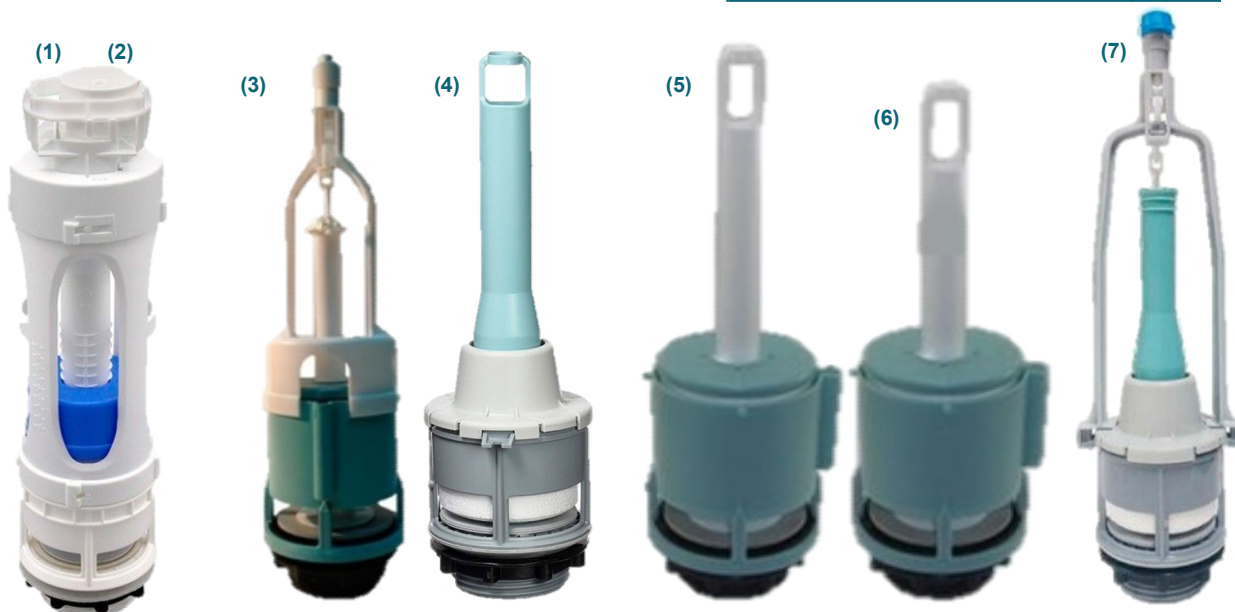

MECANISMOS DESCARGA

(1)	D1D para doble pulsador (varilla recortable)		560208710	31,30
(2)	D2D para doble pulsador (varilla rosacable)		560208700	30,60
(3)	D1P con tirante guía para pulsador enrasado y elevado		560208701	30,10
(4)	D4T tirador interrumpible	Victoria	560208702	26,60
(5)	D1T tirador no interrumpible	Meridian, Gondola, Lorentina, Carena, Lucerna, Estudio	560207650	28,50
(6)	D3T tirador no interrumpible	Victoria, Dama, Aquaria, Liberty	560207630	28,50
(7)	Mecanismos de descarga D2P con tirante para pulsador enrasado	Victoria	560207640	28,00



TIRANTE GUÍA

(1)	Para descarga D4T	560208600	3,21
(2)	Para descarga D1T	560208622	3,04
(3)	Para descarga D3T	560208610	3,42

REPUESTOS ROCA

MEDIDA REF. €



BISAGRAS ACERO VICTORIA

560201655 14,30



BISAGRAS DAMA

560201622 9,68



BISAGRAS DAMA S - GIRALDA

560200210 10,20



560200250 4,10

FIJ. BISAGRA DAMA S - GIRALDA



BISAGRA AMORTIGUADA (Todas Series)

560201612 81,80



KIT JUNTA TAZA DAMA SENSO C

560207300 6,33



KIT JUNTA TAZA VICTORIA

560207400 5,94

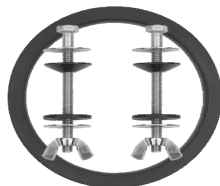

KIT JUNTA TAZA (Resto Series)

560208000 6,50



JUNTA PLANA

560205674 2,66



CONJUNTO PULSADOR ENRASADO

Para descarga D1P y D2P
Victoria, Dama,
Veronica, Liberty

(1) 560207683 12,00

Para descarga D1P

Meridian, Sidney, Georgia

(2) 560208707 13,30

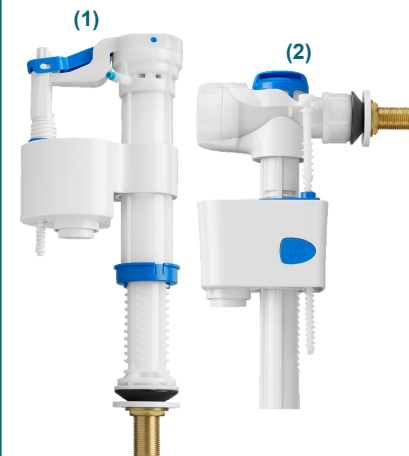

COMPACT: Alimentación inferior

Mecanismo de alimentación A4I_m, entrada inferior con rosca metálica. Compacto y llenado rápido

560207670 22,40

COMPACT: Alimentación lateral

Mecanismo de alimentación A4I_m, entrada lateral con rosca metálica. Compacto y llenado rápido

560200680 18,70

MECANISMO UNIVERSAL ROCA DESCARGA DOBLE

Mecanismo de doble descarga D2D N (6/3 O 4,5 litros) con dos pulsadores (estrecho y ancho)

ACCESS, AMERICA, CIVIC, DAMA, DEBBA, ELEMENT, GEORGIA, GIRALDA, HALL, HAPPENING, INSPIRA, LIBERTY, MERIDIAN, SIDNEY, THE GAP, VERANDA, VERONICA, VICTORIA, BEYOND, INSPIRA

560202100 38,90

MECANISMO UNIVERSAL ROCA DESCARGA SIMPLE

















Mecanismo de descarga simple D2P (6 litros interrumpible) con 4 pulsadores (cortos y largos, diámetro 27 y diámetro 40)

ELEMENT, AMERICA, HAPPENING, HALL, MERIDIAN, DAMA, GIRALDA, VICTORIA, GEORGIA, VERANDA, CIVIC, VERONICA, SYDNEY, THE GAP, LIBERTY, DEBBA

560202200 31,70



COMPLEMENTOS WC

	REF.	€		REF.	€
 <p>MANGUITO WC Extensible</p>	(100mm - 160mm)		 <p>DAKOTA</p>	110(15cm)	991364997 11,57
	991303130	16,12		110 (21 cm)	991393050 16,53
	(140mm - 290mm)			MANGUITO WC Dual	
	991364990	20,34			
	(310mm - 860mm)				
	991303133	17,82			
	110	991304040 7,61		90	991304010 5,04
				110	991364981 5,22
	DUALFLESS			110	991364983 5,36
	110	991364991 21,36		(2cm) exc.	
	TIGRIS			110	991364982 5,33
	110	991302081 32,94		(4cm) exc.	
	KILLIN			110	991362080 12,59
	110	991364986 6,32		(8cm) exc.	
				90/110 EXCENTRICO	991364999 11,20
	110	991364985 22,15		90/110 RECTO	991364998 10,09
	LUGANO		MANGUITO INODORO RECTO	MANGUITO INODORO EXCENTRICO	
	(250mm - 400mm)				
CORTO	991364995 14,87			991364989 16,29	
				ANTIRETORNO WC	
	LEMAN			FORRES	
	(320mm - 540mm)			991362072 14,08	MANGUITO WC INJERTO
LARGO	991364996 15,22				
	IMOLA				
	110	991364988 18,08			

SERIES DE PORCELANA UNISAN



EASY

LAVABO 60	560813132	54,00
LAVABO 55	560813131	49,00
LAVABO 50	560813133	48,00

PEDESTAL	560813120	41,00
----------	-----------	-------

TAZA RIMFLUSH S/DUAL	560813023	84,00
----------------------	-----------	-------

DEPÓSITO (A/I)	560813111	113,00
DEPÓSITO (A/L)	560813111	113,00

ASIENTO	560813231	49,00
ASIENTO SLOWCLOSE	560813232	64,00

BIDÉ	560813143	68,00
------	-----------	-------



WINNER

TAZA RIMFLUSH S/DUAL	561516001	121,00
----------------------	-----------	--------

DEPÓSITO A/I	561516002	146,00
DEPÓSITO A/S	561516003	146,00

ASIENTO SLIM AMORTIGUADO	561516004	73,00
--------------------------	-----------	-------

BIDÉ	561516005	105,00
------	-----------	--------

SERIES DE PORCELANA UNISAN



LOOK

TAZA S/DUAL compacto RIMFLUSH	561514534	160,00
TAZA S/DUAL compacto	561514021	150,00
DEPÓSITO A/INF	561514111	146,00
ASIENTO DUROPLAST	561514011	65,00
ASIENTO AMORTIGUADO	561514031	79,00
ASIENTO SLIM AMORTIGUADO *	561514241	79,00
110	991364981	4,88
BIDET	561514041	112,00
TAPA BIDET AMORTIGUADA	561514441	79,00



URB.Y PLUS

TAZA S/DUAL	561520510	234,00
DEPÓSITO A/	561520171	179,00
DEPÓSITO A/S	140173	179,00
ASIENTO DUROPLAST	561522011	66,00
ASIENTO AMORTIGUADO	561522031	82,00
ASIENTO SLIM AMORTIGUADO *	561520240	82,00
BIDÉ	561520511	214,00

COMPLEMENTOS WC

REF. €

REF. €



DESCARGA LOOK	560800302	38,80
---------------	-----------	-------

DESCARGA EASY	560803302	38,80
---------------	-----------	-------



GOMA OBTURADORA	560800170	2,20
-----------------	-----------	------



PULSADOR DOBLE CORMO	560800011	12,00
----------------------	-----------	-------



ALIM. INF. LOOK	560800303	38,80
-----------------	-----------	-------

SERIES SUSPENDIDA

REF.

€



SERIE LOOK



INODORO RIMFLUSH	134034	189,00
ASIENTO AMORTIGUADO	561514031	79,00
ASIENTO DUROPLAST	561514011	65,00
ASIENTO SLIM AMORTIGUADO *	561514241	79,00
BIDÉ SUSPENDIDO	561514555	215,00
TAPA BIDÉ AMORTIGUADA	561514441	79,00



SERIE URBY



INODORO 48cm	561520451	220,00
INODORO 52cm	561520455	235,00
ASIENTO AMORTIGUADO	561522031	82,00
ASIENTO DUROPLAST	561522011	66,00
ASIENTO SLIM AMORTIGUADO *	2406104	82,00
BIDÉ 52	561520450	216,00

SERIES TANQUE ALTO - ADOSADO A PARED

REF.

€



EASY



WINNER

EASY T/A	560813103	96,00
TAPA EASY AMORTIGUADO	560813232	64,00
WINNER T/A	561517420	107,00
TAPA WINNER AMORTIGUADO	561516004	73,00

CISTERNAS EMPOTRADAS

REF. €



**SANFLUSH -
PAREDES
OBRA**

560800422
164,00 €



**SANFIX -
PAREDES
LIGERAS**

560800420
284,00 €



**SWITCH -
INODORO
CISTERNA
ALTA**

560800423
143,00 €

	<u>PLAN</u>	<u>ORANGE</u>	<u>EASY</u>
NEGRO MATE			
	4001326 68,00 €	4000326 68,00 €	
CROMO SATINADO			
	560800020 68,00 €	560800023 68,00 €	560800017 59,00 €
CROMO BRILLO			
	560800019 68,00 €	560800022 68,00 €	560800016 59,00 €
BLANCO			
	560800018 45,00 €	560800021 45,00 €	560800015 43,00 €

ASIENTOS WC

Compatibilidad:

GRECIA



PORSAN (Venecia)
ROCA (Lucerna / Victoria / Zoom)

991321010 29,95

SANGRÁ (Boreal)
UNISAN (Cetus)

991321011 40,87

MANCHESTER



BELLAVISTA (New / Style)
ROCA (Happening / Inspira / Meridian)

991321031 48,10

GALA (Bácara / Emm2 / Marina Vertical)
UNISAN (Urby / Proget Gafort / Alfa Plus)

NAUTIC

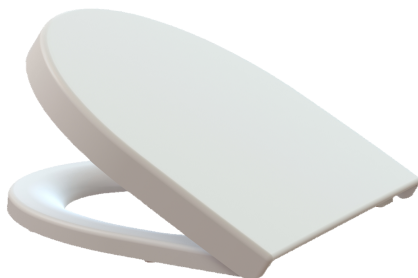

MARINA (Gala)
FIJACIÓN HORIZONTAL

991321050 39,52

OBYECT



ROCA (Dama Senso)

991321020 56,36

GALA (Smart)

DUCHAS HIGIÉNICAS



	REF.	€		REF.	€
<p>MEZCALDOR EMPOTRADO AGUA FRÍA Y CALIENTE</p>	320170000	61,25	<p>VÁLVULA CON SALIDA CISTERNA AGUA FRÍA</p>	320170001	31,25
				<p>REPUESTO FLEXO</p>	320170001

SERIE WINNER CONFORT (Movilidad Reducida - PMR)

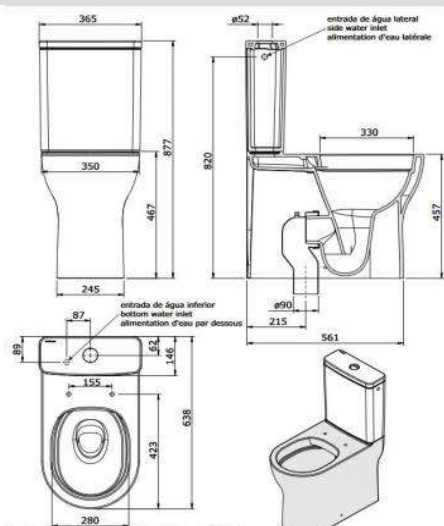

REF.	€	REF.	€
		TAZA RIMFLUSH S/DUAL	561518001 153,00
		DEPÓSITO A/I	561516002 146,00
		DEPÓSITO A/S	561516003 146,00
		ASIENTO SLIM SLOWCLOSE	561516004 73,00

ASIDEROS



BLANCO	REF.	€	SATINADO	REF.	€
	120230002	21,15		120230003	31,90
30 CM			30 CM		
	120230002	87,00		120230004	124,00
80 CM			80 CM		

COLECTIVAS Y LAVABOS

REF.	€	REF.	€
	LAVAMANOS 45 cm 560810834 48,00	ATLÁNTICO (1)	RÍA (2)
			(1)
			560810851 314,00
			(2)
		770x485x340	425x310x255
			S/V
			560803011 72,00
			UNISAN
			S/H
			560803012 72,00
			S/V
			560210058 66,90
			ROCA
			S/H
			560210064 66,90
			INODORO PARA CISTERNA ALTA

	RIBA 40 560810100 118,00
	SOPORTE 560694030 31,00
600x390x345	
	VERTEDERO 560801186 184,00
	REJA VERTEDERO 560801861 80,00
510x410x395	

ACCESORIOS DE BAÑO

NIZA	REF.	€	CRETA	REF.	€
	120231001	26,05		120232001	35,10
	120231002	39,70		120232002	49,80
	120231003	28,70		120232003	44,70
	120231004	14,55		120232004	22,50
	120231005	29,30		120232005	12,00
	120231006	26,05		120100080	35,00
			PORTAROLLO + LLAVE CORTE		
			C-80		
			1/2 x 3/8		

PLATOS DE DUCHA NATURE

LARGO	ANCHO 70x		ANCHO 75x		ANCHO 80x		ANCHO 90x			
	REF.	€	REF.	€	REF.	€	REF.	€		
80 cm	5625+		+08070	211,00	+08075	-	+08080	229,00	-	-
90 cm	5625+		+09070	224,00	+09075	228,00	+09080	246,00	+09090	262,00
100 cm	5625+		+10070	248,00	+10075	258,00	+10080	266,00	+10090	280,00
110 cm	5625+		+11070	267,00	+11075	270,00	+11080	280,00	+11090	304,00
120 cm	5625+		+12070	286,00	+12075	289,00	+12080	307,00	+12090	326,00
130 cm	5625+		+13070	304,00	+13075	323,00	+13080	321,00	+13090	339,00
140 cm	5625+		+14070	312,00	+14075	323,00	+14080	336,00	+14090	349,00
150 cm	5625+		+15070	332,00	+15075	351,00	+15080	344,00	+15090	365,00
160 cm	5625+		+16070	344,00	+16075	351,00	+16080	359,00	+16090	376,00
170 cm	5625+		+17070	365,00	+17075	390,00	+17080	391,00	+17090	423,00
180 cm	5625+		+18070	384,00	+18075	390,00	+18080	405,00	+18090	442,00
190 cm	5625+		+19070	411,00	+19075	433,00	+19080	434,00	+19090	492,00
200 cm	5625+		+20070	421,00	+20075	433,00	+20080	454,00	+20090	514,00



**INCLUYE
VÁLVULA**



GRIS (7037)

GRIS PERLA (7035)

BEIGE (9001)

MOKA (1001)

BLANCO (9003)

GRAFITO (7016)

PLATOS DE DUCHA HERMES

LARGO	ANCHO 70x		ANCHO 80x		ANCHO 90x		ANCHO 100x			
	REF.	€	REF.	€	REF.	€	REF.	€		
100 cm	5624+		+10070	248,00	+10080	266,00	-	281,00	-	301,00
110 cm	5624+		+11070	-	+11080	-	-	-	-	-
120 cm	5624+		+12070	286,00	+12080	307,00	-	326,00	-	351,00
130 cm	5624+		+13070	-	+13080	-	-	-	-	-
140 cm	5624+		+14070	312,00	+14080	336,00	-	350,00	-	388,00
150 cm	5624+		+15070	332,00	+15080	343,00	-	365,00	-	405,00
160 cm	5624+		+16070	343,00	+16080	359,00	-	376,00	-	422,00
170 cm	5624+		+17070	365,00	+17080	391,00	-	423,00	-	479,00
180 cm	5624+		+18070	384,00	+18080	405,00	-	442,00	-	506,00
190 cm	5624+		+19070	-	+19080	-	-	-	-	-
200 cm	5624+		+20070	421,00	+20080	454,00	-	514,00	-	546,00



**INCLUYE
VÁLVULA**



COMPLEMENTOS PLATOS DE DUCHA OBRA

MOD. GDANSK



DIMENSIONES:

- ALTURA MIN: 75 mm
- ALTURA MAX: 115 mm
- ANCHO: 118 mm
- ANCHO HUECO: 80 mm
- LITROS / MINUTO: 56 l/min - EN274
- DIÁMETRO SALIDA: Ø 50
- RESISTENCIA REJILLA: 300 Kgs.
- MATERIAL: 100% Fabricado INOX. AISI 304

DISEÑO REJILLA GDANSK



REFERENCIA	MEDIDA	PVP
991324061	600 mm	172,66
991324071	700 mm	182,31
991324081	800 mm	192,06
991324091	900 mm	201,89

LÁMINA GEOTEXTIL IMPERMEABILIZANTE

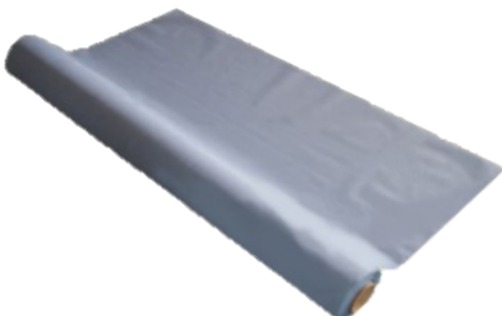

300 x 100 (3m ²)	991329021	42,12
------------------------------	------------------	--------------

¿Por qué Vaillant?

Soluciones con la máxima eficiencia energética



Porque  **Vaillant** piensa en futuro.

MAMPARAS



FADO

ANCHURA (F) cm	ANCHURA (L) cm	VIDRIO TRANSPARENTE 6 mm			
		PLATA ALTO BRILLO		NEGRO	
		CÓDIGO	PVP/€	CÓDIGO	PVP/€
FD - 90	90 - 91	121000101	295,00	20069013	325,00
FD - 100	100 - 101	121000102	306,00	20061013	337,00
FD - 110	110 - 111	121000103	320,00	20061113	351,00
FD - 120	120 - 121	121000104	332,00	20061213	362,00



SALMA SA - 320

MEDIDAS (LI + LD) cm	ANCHURA (mm)	TRANSPARENTE		SATINADO BOLD	
		PLATA ALTO BRILLO		PLATA ALTO BRILLO	
		CÓDIGO	PVP/€	CÓDIGO	PVP/€
77,5-79x77,5-79	401	22453011	544,00	22453012	592,00
87,5-89x87,5-89	472	22453021	568,00	22453022	616,00
87,5-89x67,5-69	407	22453031	544,00	22453032	592,00
97,5-99x67,5-69	449	22453041	551,00	22453042	604,00
97,5-99x77,5-79	477	22453051	563,00	22453052	616,00
117,5-119x67,5-69	537	22453061	574,00	22453062	640,00
117,5-119x77,5-79	560	22453071	587,00	22453072	651,00
117,5-119x87,5-89	587	22453081	598,00	22453082	663,00
137,5-139x67,5-69	628	22453091	609,00	22453092	670,00
137,5-139x77,5-79	649	22453101	621,00	22453102	681,00

* En perfilera color negro sumar 20€ a la transparente alto brillo



SPG - 320

MEDIDAS (LI + LD) cm	ANCHURA (mm)	TRANSPARENTE		SATINADO BOLD	
		PLATA ALTO BRILLO		PLATA ALTO BRILLO	
		CÓDIGO	PVP/€	CÓDIGO	PVP/€
77-80x77-80	42	2426011	554,00	24280114	573,00
97-100x67-80	46	2426041	561,00	24280414	581,00
77-100x77-80	49	2426051	568,00	24280514	587,00
117-120x67-80	55	2426061	575,00	24280614	594,00
117-120x77-80	57	2426071	583,00	24280714	601,00
137-140x67-70	64	2426081	671,00	24280814	690,00
137-140x77-80	66	2426091	676,00	24280914	694,00



SALMA SA - 310

ANCHURA (F) cm	APERTURA (mm)	TRANSPARENTE		SATINADO BOLD	
		PLATA ALTO BRILLO		PLATA ALTO BRILLO	
		CÓDIGO	PVP/€	CÓDIGO	PVP/€
115-118	469	121000001	383,00	22451052	417,00
118-121	484	121000002	390,00	22451062	425,00
125-128	519	121000003	396,00	22451072	434,00
128-131	534	121000004	404,00	22451082	442,00
135-138	569	121000005	411,00	22451092	450,00
138-141	584	121000006	418,00	22451102	459,00
145-148	619	121000007	425,00	22451112	467,00
148-151	634	121000008	433,00	22451122	475,00
155-158	669	121000009	440,00	22451132	483,00
158-161	684	121000010	446,00	22451142	492,00
165-168	719	121000011	453,00	22451152	500,00
168-171	734	121000012	461,00	22451162	508,00
175-178	769	121000013	468,00	22451172	516,00

* En perfilería color negro sumar 20€ a la transparente alto brillo



SPG - 310

ANCHURA (F) cm	APERTURA (mm)	TRANSPARENTE		SATINADO BOLD	
		PLATA ALTO BRILLO		PLATA ALTO BRILLO	
		CÓDIGO	PVP/€	CÓDIGO	PVP/€
114-120	46	2416201	424,00	24182014	444,00
120-126	49	2416261	428,00	24182614	448,00
126-132	52	2416321	431,00	24183214	450,00
132-138	55	2416381	436,00	24183814	455,00
138-144	58	2416441	440,00	24184414	457,00
144-150	61	2416501	445,00	24185014	464,00
150-156	64	2416561	454,00	24185614	472,00
156-162	67	2416621	461,00	24186214	478,00
162-168	7	2416681	468,00	24186814	486,00
168-174	73	2416741	483,00	24187414	502,00
174-180	76	2416801	504,00	24188014	524,00



SALMA

SA-310+LDF-SA

ANCHURA (F) cm	APERTURA (mm)	ANCHURA FIJO (L) cm LDF-SA	TRANSPARENTE			SATINADO BOLD		
			PLATA ALTO BRILLO			PLATA ALTO BRILLO		
			CÓDIGO		PVP/€	CÓDIGO		PVP/€
			FRONTAL	LATERAL		FRONTAL	LATERAL	
115-118	469	67-69	22451051	22454011	614,00	22451052	22454012	472,00
		77-79		22454021	626,00		22454022	684,00
118-121	484	67-69	22451061	22454011	621,00	22451062	22454012	680,00
		77-79		22454021	633,00		22454022	692,00
125-128	519	67-69	22451071	22454011	627,00	22451072	22454012	688,00
		77-79		22454021	640,00		22454022	701,00
128-131	534	67-69	22451081	22454011	634,00	22451082	22454012	697,00
		77-79		22454021	647,00		22454022	709,00
135-138	569	67-69	22451091	22454011	642,00	22451092	22454012	705,00
		77-79		22454021	654,00		22454022	717,00
138-141	584	67-69	22451101	22454011	649,00	22451102	22454012	713,00
		77-79		22454021	661,00		22454022	726,00
145-148	619	67-69	22451111	22454011	656,00	22451112	22454012	721,00
		77-79		22454021	669,00		22454022	734,00
148-151	634	67-69	22451121	22454011	663,00	22451122	22454012	730,00
		77-79		22454021	676,00		22454022	742,00
155-158	669	67-69	22451131	22454011	671,00	22451132	22454012	741,00
		77-79		22454021	683,00		22454022	750,00
158-161	684	67-69	22451141	22454011	677,00	22451142	22454012	742,00
		77-79		22454021	689,00		22454022	759,00
165-168	719	67-69	22451151	22454011	684,00	22451152	22454012	755,00
		77-79		22454021	697,00		22454022	767,00
168-171	734	67-69	22451161	22454011	691,00	22451162	22454012	763,00
		77-79		22454021	703,00		22454022	775,00
175-178	769	67-69	22451171	22454011	698,00	22451172	22454012	771,00
		77-79		22454021	711,00		22454022	783,00

MAMPARAS



**SRING
SPG-310+LDF-SPG**

ANCHURA (F) cm	APERTURA (mm)	ANCHURA FIJO (L) cm LDF-SA	TRANSPARENTE			SATINADO BOLD		
			PLATA ALTO BRILLO			PLATA ALTO BRILLO		
			CÓDIGO		PVP/€	CÓDIGO		PVP/€
			FRONTAL	LATERAL		FRONTAL	LATERAL	
111-114	46	67-70	2416201	200214170	617,00	24182014	20024172	654,00
		77-80	2416201	200214180	626,00	24182014	20024182	664,00
117-120	49	67-70	2416261	200214170	621,00	24182614	20024172	658,00
		77-80	2416261	200214180	631,00	24182614	20024182	669,00
123-126	52	67-70	2416361	200214170	623,00	24183214	20024172	659,00
		77-80	2416361	200214180	632,00	24183214	20024182	671,00
129-132	55	67-70	2546381	200214170	628,00	24183814	20024172	666,00
		77-80	2546381	200214180	638,00	24183814	20024182	676,00
135-138	58	67-70	2416441	200214170	632,00	24184414	20024172	667,00
		77-80	2416441	200214180	642,00	24184414	20024182	678,00
141-144	61	67-70	2416501	200214170	638,00	24185014	20024172	673,00
		77-80	2416501	200214180	647,00	24185014	20024182	684,00
147-150	64	67-70	2416561	200214170	647,00	24185614	20024172	681,00
		77-80	2416561	200214180	656,00	24185614	20024182	692,00
153-156	67	67-70	2416621	200214170	653,00	24186214	20024172	687,00
		77-80	2416621	200214180	662,00	24186214	20024182	699,00
159-162	70	67-70	2416681	200214170	661,00	24186814	20024172	696,00
		77-80	2416681	200214180	670,00	24186814	20024182	707,00
165-168	73	67-70	2416741	200214170	676,00	24187414	20024172	711,00
		77-80	2416741	200214180	685,00	24187414	20024182	722,00
171-174	76	67-70	2416801	200214170	696,00	24188014	20024172	733,00
		77-80	2416801	200214180	706,00	24188014	20024182	744,00



Solución C-80

Portarrollo con llave de escuadra



DUCHAS Y COMPLEMENTOS

BLAUTHERM



MONOMANDO
EXTENSIBLE

400509344
466,00 €



MONOMANDO EXTENSIBLE
ROCIADOR CUADRADO

400509345
445,00 €

EMPOTRADAS (BLAUTHERM)



Todo en 1 caja
KIT EMPOTRADO
CROMO

400509706
300,00 €



Todo en 1 caja
KIT EMPOTRADO
NEGRO

400509707
450,00 €

DUCHAS Y COMPLEMENTOS



COLUMNA DUCHA
KORAL EXTENSIBLE
NEGRO

402168200
537,20



COLUMNA DUCHA
KORAL EXTENSIBLE
CROMO

402168100
378,31



COLUMNA DUCHA SIN
GRIFERIA

402165215
237,18

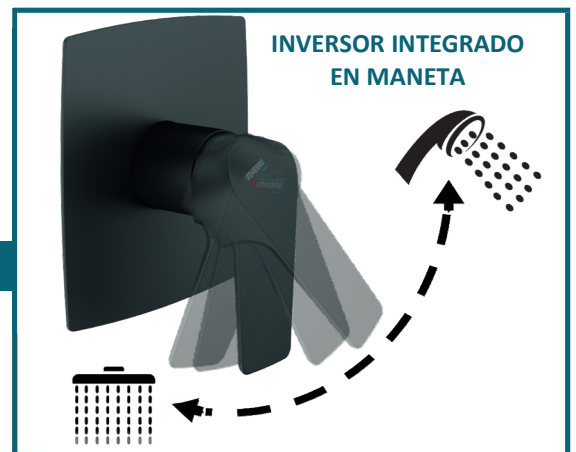

INVERSOR INTEGRADO
EN MANETA

EMPOTRADAS

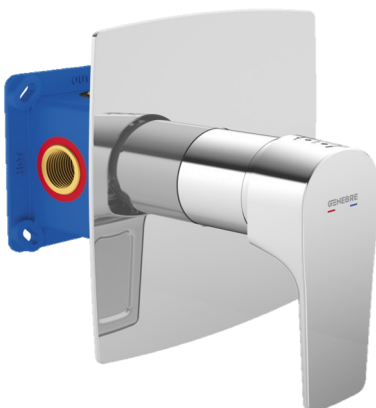

CROMO



NEGRO

CROMO	402168108	128,90
-------	-----------	--------

NEGRO	402168206	174,30
-------	-----------	--------

DUCHAS Y COMPLEMENTOS

BARRA DUCHA



400803742

42,67 €

MANERALES



SKARA

400803706

12,33 €



AQUA 1.0

400803710

8,33 €



AQUA 3.0

400803715

10,33 €



ECO

400803703

4,00 €

ROCIADORES



ABS ROTULA

400803406

4,10 €



AQUA

400803409

12,33 €



ACERO 20cm

400803440

26,67 €

BRAZOS



1/2 x 30 cm

400803301

9,33 €



TECHO

400803308

9,67 €



INCLINADO

400803310

10,00 €

SOPORTES



CODO TOMA

400803631

16,67 €



SOPORTE TOMA

400803630

16,00 €



ERGOS

400803626

7,53 €



NATURA

400803621

3,20 €



Almacén de Fontanería

Regístrate en nuestro ecommerce

Descúbrelo en
tienda.suministroscoplasa.es

Podrás consultar tus documentos
Ofertas - Pedidos - Albaranes - Facturas



También pedir
materiales 24h



Fácil, rápido y GRATIS

Captura con tu móvil este código QR
para acceder a un vídeo explicativo.

CONJUNTO CHEAP



3 cajones
Muebles 80cm + Lavabo

**No incluye grifería*

NETO

121200503 **255,00 €**

CONJUNTO CHEAP SUSPENDIDO



2 cajones
Muebles 60cm + Lavabo

**No incluye grifería*

NETO

121200501 **175,00 €**

Mueble 80cm + lavabo

NETO

121200502 **195,00 €**

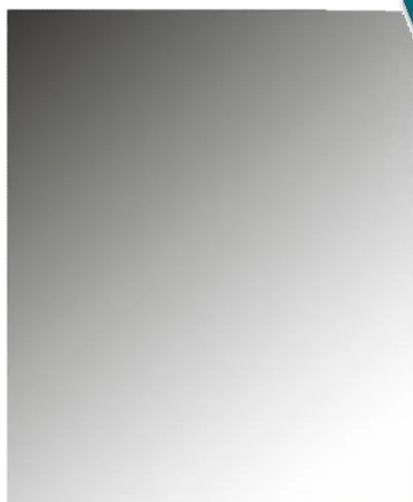

ESPEJO REVERSIBLE 80.60

120207049
39,00



APLIQUE LED

120207643
34,00



**CONJUNTO
VITALE SUSPENDIDO**

50cm
2 cajones
**F35 (fondo
reducido)**

**Mueble +
Lavabo +
Espejo liso**

***No incluye
grifería ni foco**

333,00

-  BL19
Blanco Nature
-  RO6
Beige Nature
-  GR37
Gris Nature
-  BL1B
Blanco Brillo
-  MA13M
Fumo Mate

**Mueble
+ Lavabo
+ Espejo liso
+ Aplique Led
80 cm**

*** No incluye grifería**

549,00



-  GR21
-  NO14
-  BL1B
-  GR16B
-  GR35B
-  RO14
-  RO13
-  AZ6B

**CONJUNTO STREET
SUSPENDIDO**

NEW FLY

TITANIUM



TOOL FREE

400557023 68,44

APERTURA EN FRIO



TOOL FREE

400501801 48,00



TOOL FREE

400557031 66,40



TOOL FREE

400501803 49,80



400557080 122,20



400501808 80,50









400557050 142,20





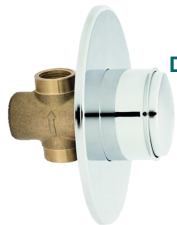





400501805 96,20

TEMPORIZADOS GENEBRE

	REF.	€		REF.	€
			LAVABO REPISA		
	401471160	50,81			
			LAVABO PARED		
	401471037	39,70			
			URINARIO		
	401471185	38,57			
			LAVABO IPSON		
	401471030	60,60			
			DUCHA EMPOTRAR 1 AGUA		
	401471173	63,05			
			TUBO URINARIO		
	401471018	11,02			

TEMPORIZADOS PRESTO

			LAVABO		
			Grifo		
	401488300	78,60			
			Montura		
	401489100	47,70			
			GRIFO URINARIO		
			Grifo		
			401488200	71,20	
			Tubo		
			401488100	20,20	
			Montura		
			401489102	47,70	
			GRIFO FRONTAL		
			401484100	66,40	
			FLUXOR WC		
			Goma		
			401489200	83,70	
			Enchufe Wc		
			401489202	4,60	
			Tubo Flexor Wc		
			401489201	37,50	
			EMPOTRADO DUCHA		
			401488400	78,80	
			CAÑO LAVABO GIRATORIO		
			401489302	70,40	
			MANETA		
	401481200	33,40			
			PISTON		
	401489847	17,80			

MONOMANDOS SERIE KORAL

		REF.	€
	MEDIO ALTO	402168107	154,26
	LAVABO	402168101	94,27
	BIDET	402168102	87,54
	BAÑO-DUCHA	402168103	162,22
	DUCHA	402168104	137,13
	EMPOTRADO 2 VÍAS	402168108	128,90
	TERMOSTÁTICA DUCHA	402167104	166,51
	MEDIO ALTO	402168205	216,00
	LAVABO	402168201	132,00
	BIDET	402168202	122,60
	BAÑO-DUCHA	402168203	227,10
	DUCHA	402168204	192,00
	EMPOTRADO 2 VÍAS	402168206	174,30
	TERMOSTÁTICA BAÑO	402167103	212,42

SERIE OSLO

SERIE OSLO NEGRO

	REF.	€		REF.	€
	MEDIO ALTO 402165134	104,68		MEDIO ALTO 402165235	215,48
	LAVABO 402165130	104,68		LAVABO 402165236	151,81
	BIDET 402165140	102,23		BIDET 402165237	148,14
	DUCHA 402165110	142,63		DUCHA 402165239	206,91
	BAÑO-DUCHA 402165100	163,45		BAÑO-DUCHA 402165238	206,91

SERIE BASIK

SERIE K8

	REF.	€
	LAVABO 402169130	55,29
	BIDET 402169140	57,10
	BAÑO-DUCHA 402169100	97,42
	DUCHA 402169110	79,95
	EMPOTRADO 402169116	83,06

	REF.	€
	LAVABO MEDIO ALTO 402133402	59,38
	LAVABO 402133401	51,43
	BIDET 402133403	50,81
	BAÑO-DUCHA 402133405	91,83
	DUCHA 402133408	71,01
	EMPOTRADO 2 VÍAS 402133116	116,36
	EMPOTRADO 1 VÍAS 402133115	93,08

GRIFERÍA CONVENCIONAL

	REF.	€		REF.	€
 <p>11 cm</p>	402068195	68,56	 <p>15 cm</p>	402068190	68,56
			 <p>REPISA</p>	402010080	36,73
 <p>PARED</p>	402010060	33,06		402010090	44,08
 <p>REPISA</p>	402010070	33,67			

			RS Ramon Soler		
	REF.	€		REF.	€
 <p>12 o 17 cm</p>	(12) 400450703	36,50	 <p>LLAVE DE PASO</p>	15	400470076 32,75
	(17) 400450708	43,05		18	400470079 54,06
				22	400470074 54,06
				1/2	400470072 38,75
				3/4	400470073 54,06



Almacén de Fontanería

**PISCINAS - FOSAS Y DEPURADORAS -
TRATAMIENTOS DE AGUA - AEROTERMIA -
CALEFACCIÓN - GRIFERÍAS - MATERIAL
CONTRAINCENDIOS - GAS -
DESCALCIFICADORES - SANITARIOS -
ACCESORIOS PARA BAÑOS PÚBLICOS -
BOMBAS DE AGUA - VALVULERÍA -
TUBERIAS - VENTILACIÓN - DEPÓSITOS -
MÁQUINAS - HERRAMIENTAS - TERMOS -
ACUMULADORES - AIRE ACONDICIONADO**

Siempre Cerca de tí

ALMACÉN

C/ JUAN RAMÓN JIMÉNEZ, 11-13
46930 QUART DE POBLET
TEL. 961548962

quart@suministroscoplasa.com

**ALMACÉN - OFICINAS
SHOWROOM**

C/ DOMINGO GÓMEZ, 23
46025 VALENCIA
TEL. OFICINAS: 963471573
TEL. ALMACÉN: 963473527

valencia@suministroscoplasa.com

www.suministroscoplasa.com



ALMACÉN

C/ TANDA XICA, 29 - NAVE 2
P.I. CAMÍ DE LA VILA
46800 XÁTIVA
TEL. 961712387

xativa@suministroscoplasa.com

**14ª Feria del
Instalador**